

HAMMERHEAD TOWER CRANE

**Specifications:**

- ▶ Max jib length: 80,00 m
- ▶ Capacity at max length: 2,30 t
- ▶ Max capacity: 20,00 t

WORKS FOR YOU.™

KEY

Legenda · Zeichenerklärung · Légende · Leyenda · Legenda · Условные обозначения



Hoisting · Sollevamento · Heben · Levage · Elevación · Elevação · Подъем



Trolleying · Traslazione carrello · Katzfahren · Distribution · Distribución · Distribuição · Передвижение каретки



Slewing · Rotazione · Schwenken · Orientation · Orientació · Giro · Поворот



Travelling · Traslazione · Schienenfahren · Translation · Traslación · Móvel · Передвижение



Directive on noise level · Direttiva sul livello acustico · Richtlinie für den Schall-Leistungspegel · Directive sur le niveau acoustique · Directiva sobre el nivel acustico · Diretiva sobre nivel de ruidos · Директива по уровню шума



Consult us · Consultateci · Auf Anfrage · Nous consulter · Consultarnos · Consulte-nos · Проконсультироваться с нами



Power requirements · Potenza totale richiesta · Geforderte Stromstärke · Puissance totale nécessaire · Potencia necesaria · Requisitos de energia · Требования по питанию



Power supply · Alimentazione · Stromversorgung · Alimentation · Alimentación · Fonte de alimentação · Питание



In service · In servizio · In Betrieb · En service · En servicio · Em serviço · При работе



Out of service · Fuori servizio · Außer Betrieb · Hors service · Fuera de servicio · Fora de serviço · В режиме простоя



Max. under hook height · Altezza max. sotto gancio · Höchste Hakenhöhe · Hauteur maxi. sous crochet · Maxima altura bajo gancho · Alt. máx. sob o gancho · Макс высота крюка



Without load, without ballast, max. jib and max. height · A vuoto, senza zavorra, braccio max., altezza max. · Ohne Last und Ballast, mit Maximalausleger und Maximalhöhe · A vide, sans lest, avec flèche et hauteur maximum · Sin carga, sin lastre, con pluma y altura máxima · Sem carga, sem lastro, lança máxima, altura máxima · Без груза, без балласта, на макс. Длине вспомогательной стрелы и макс. Высоте



Counterweight · Zavorra controbraccio · Gegengewicht · Lest de contre-flèche · Lastre de contra flecha · Contrapeso · Противовес

C25

EN 14439-C25 · EN 14439 - C25 · EN14439 - C25 · EN 14439 - C25 · EN 14439 - C25 · EN 14439 - C25 · EN14439 - C25

CONTENTS

SK 415-20

Indice · Inhalt · Contenu · Contenido · Sumário · Содержание

Page · Pagina · Seite · Page · Página · Página · Страница:

Load Diagram · Diagramma di portata · Lastkurven · Courbes de charges · Curvas de cargas · Diagrama de carga · Диаграмма грузоподъёмности	4
Tower · Torre · Turm · Tour · Torre · Torre · Башня	6
Mechanisms · Meccanismi · Antriebe · Mécanismes · Mecanismos · Mecanismo · Механизм	8
Transportation · Trasporto · Transport · Transport · Transporte · Transporte · Транспортировка	10

LOAD DIAGRAM

Lastkurven · Diagramma di portata · Courbes de charges · Curvas de cargas · Diagrama de carga · Диаграмма грузоподъёмности

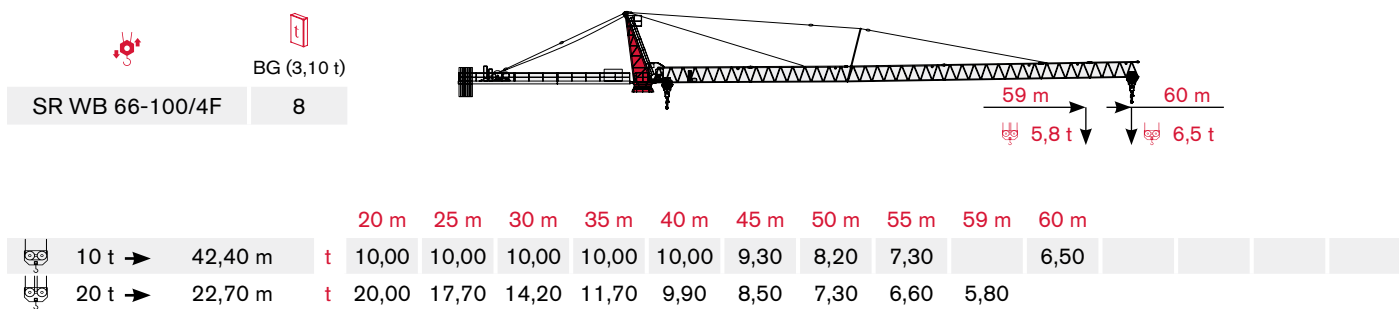
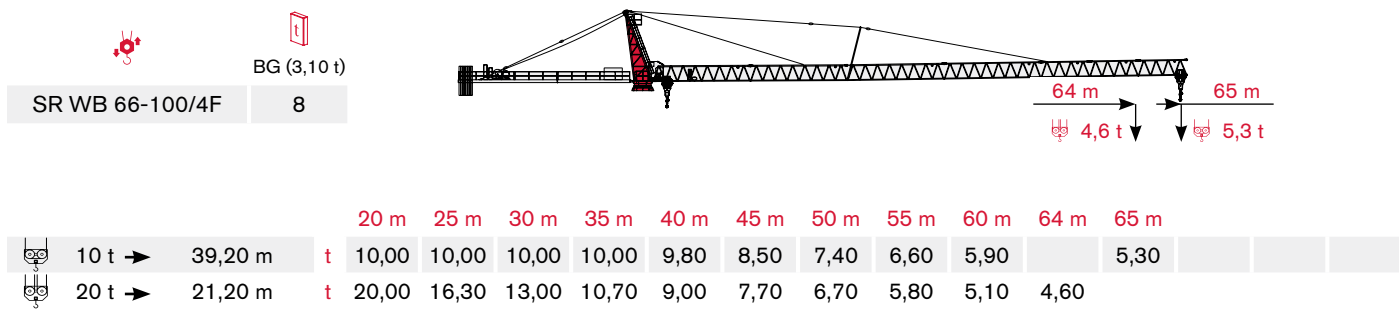
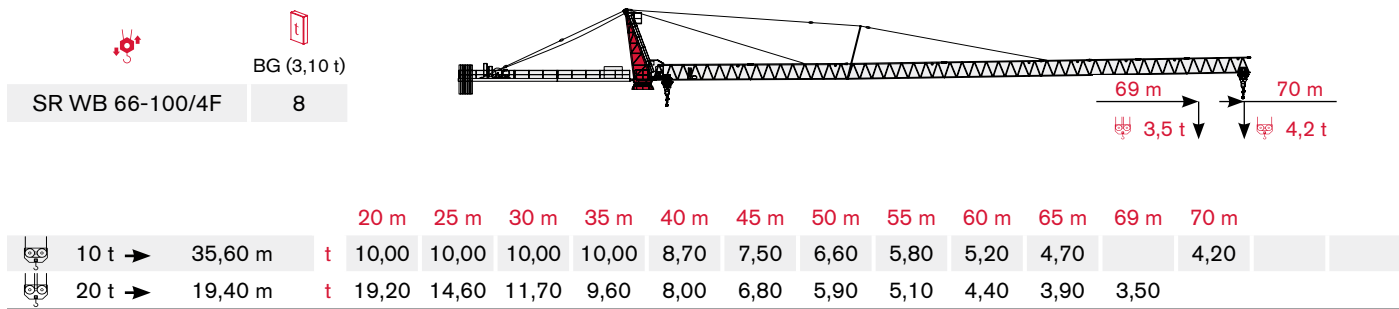
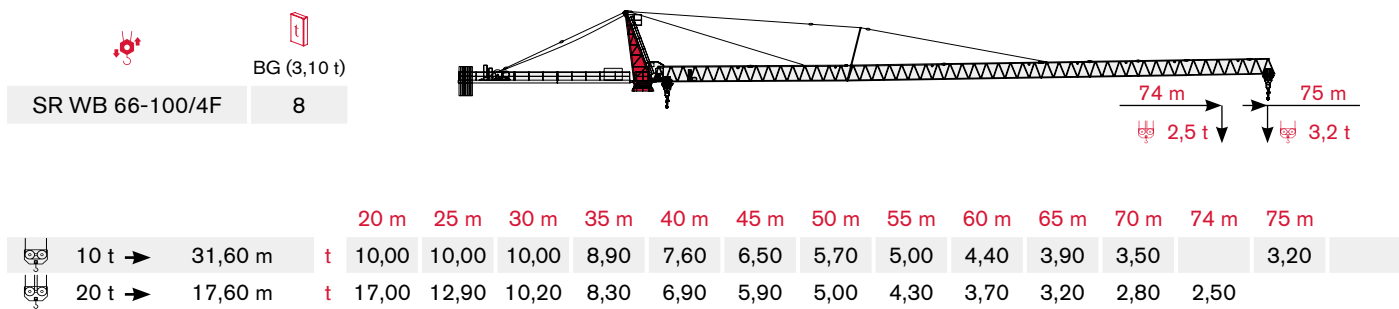
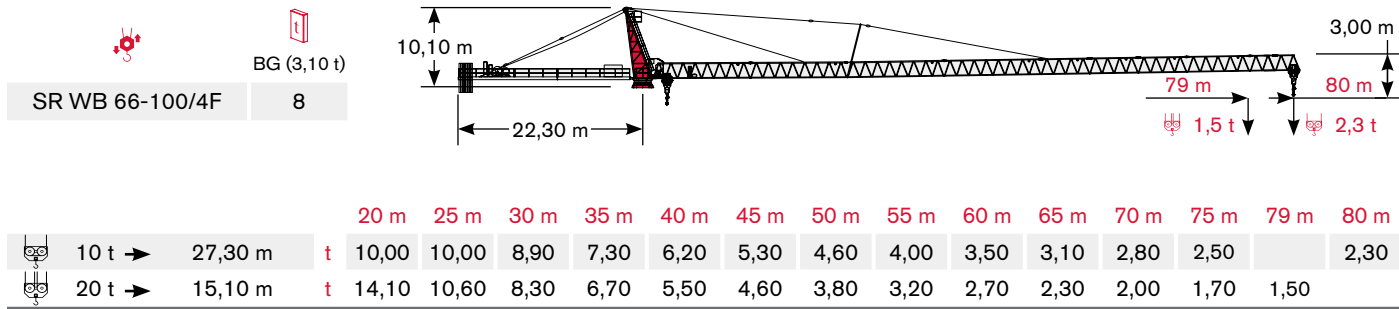

SR WB 66-100/4F
BG (3,10 t)
7

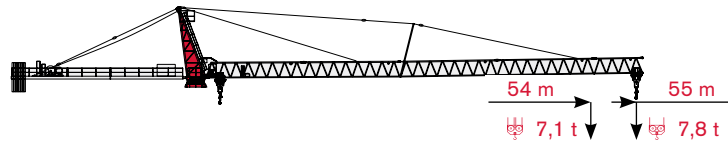

			20 m	25 m	30 m	35 m	40 m	45 m	50 m	54 m	55 m				
10 t →	45,00 m	t	10,00	10,00	10,00	10,00	10,00	10,00	8,80		7,80				
20 t →	24,00 m	t	20,00	18,80	15,1	12,50	10,60	9,10	7,90	7,10					

SR WB 66-100/4F
BG (3,10 t)
7

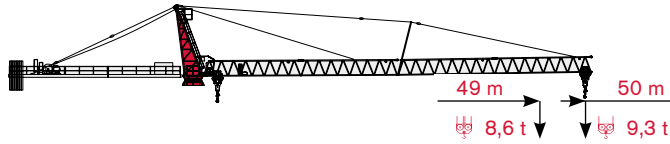

			20 m	25 m	30 m	35 m	40 m	45 m	49 m	50 m					
10 t →	47,30 m	t	10,00	10,00	10,00	10,00	10,00	10,00		9,30					
20 t →	25,10 m	t	20,00	20,00	16,00	13,20	11,20	9,60	8,60						

SR WB 66-100/4F
BG (3,10 t)
7

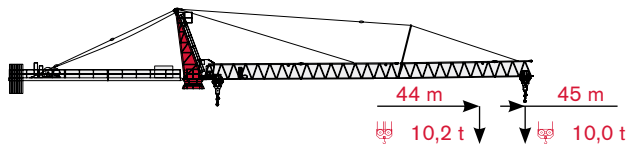

			20 m	25 m	30 m	35 m	40 m	44 m	45 m						
10 t →	45,00 m	t	10,00	10,00	10,00	10,00	10,00		10,00						
20 t →	25,60 m	t	20,00	20,00	16,40	13,60	11,50	10,20							

SR WB 66-100/4F
BG (3,10 t)
6

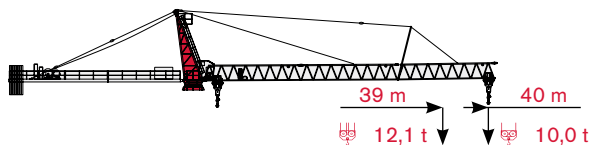

			20 m	25 m	30 m	35 m	39 m	40 m							
10 t →	40,00 m	t	10,00	10,00	10,00	10,00		10,00							
20 t →	26,00 m	t	20,00	20,00	16,60	13,80	12,10								

SR WB 66-100/4F
BG (3,10 t)
6

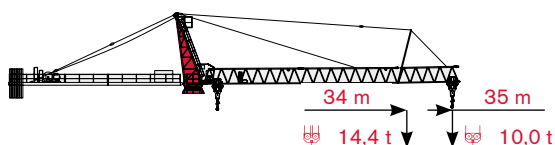

			20 m	25 m	30 m	34 m	35 m								
10 t →	35,00 m	t	10,00	10,00	10,00		10,00								
20 t →	26,10 m	t	20,00	20,00	16,70	14,40									

TOWER

Torre · Turm · Tour · Torre · Torre · Башня

Standard Configurations · Installazioni Standard · Standardkonfiguration · Standard Implantations · Implantaciones Standard · Configuração padrão · Стандартная конфигурация крана

Basement: A

	●	◆
R1	-2655 kN	-2755 kN
R2	1992 kN	2186 kN
	890 kN	

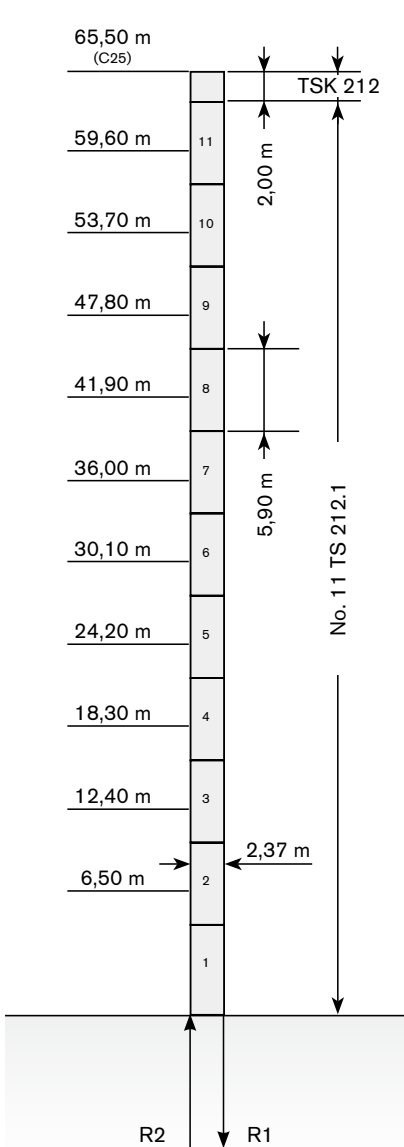

Basement: E

	●	◆
R1	-1121 kN	-1099 kN
R2	0 kN	-51 kN
	978 kN	

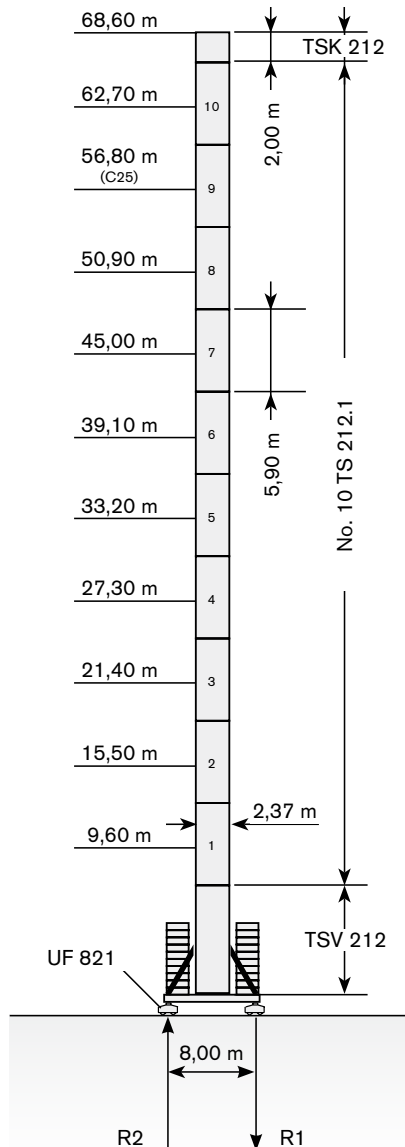

Basement: F

	●	◆
R1	1099 kN	-1113 kN
R2	0 kN	-18 kN
	978 kN	

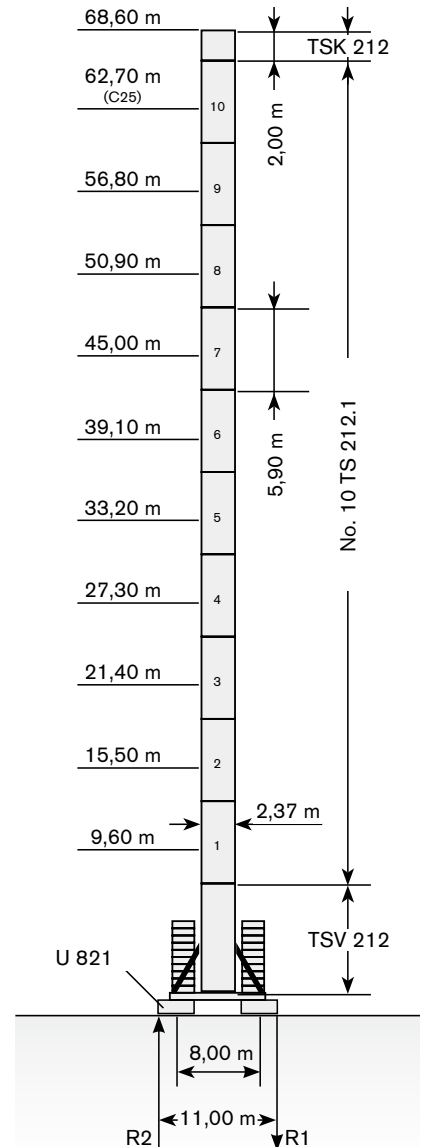

Max. under hook height · Altezza max. sotto gancio · Höchste Hakenhöhe · Hauteur maxi. sous crochet · Maxima altura bajo gancho · Alt. máx. sob o gancho · макс высота крюка

Different heights and tower combinations are available; please consult us · Altezze diverse e combinazioni di torre sono disponibili; consultateci · Andere Höhen und Turmkombinationen auf Anfrage · Différentes hauteurs et combinaisons de tour sont disponibles; nous consulter · Hay diferentes alturas y combinaciones de torre disponibles. Consúltenos · Diferentes alturas e combinações de torres disponíveis; fale conosco · Возможны другие сочетания высоты и конфигурации башни; проконсультируйтесь с нами

Other configurations · Altre Installazioni · Aufstellmöglichkeiten · Autres Implantations · Otras Implantaciones · Outras configurações · Другие конфигурации

Bottom climbing crane · Gru climbing · Kletterkran im Gebäude · Télescopage sur dalles · Telescopage grúa trepadora · Guindaste automontante interno · Самоподъемный кран

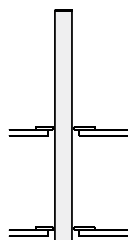

Crane tied to the structure · Gru ancorata · Geankerter Kran · Grue ancrée · Grúa anclada · Guindaste ancorado na estrutura · Кран, крепящийся к сооружению

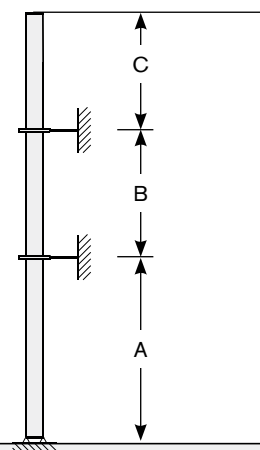

	min	max
A	20,80 m	51,30 m
B	14,80 m	35,90 m
C	50,40 m	





Different heights and tower combinations are available; please consult us · Altezze diverse e combinazioni di torre sono disponibili; consultateci · Andere Höhen und Turmkombinationen auf Anfrage · Différentes hauteurs et combinaisons de tour sont disponibles; nous consulter · Hay diferentes alturas y combinaciones de torre disponibles. Consúltenos · Diferentes alturas e combinações de torres disponíveis; fale conosco · Возможны другие сочетания высоты и конфигурации башни; проконсультируйтесь с нами







MECHANISMS

Meccanismi · Antriebe · Mécanismes · Mecanismos · Mecanismo · Механизм

Power supply · Alimentazione · Stromversorgung · Alimentation · Suministro eléctrico · Requisitos de energia · Требования по питанию

	SR WB 66-100/4F		
	SR WB 66-100/4F	132 kVA	480V - 60Hz / 400V - 50Hz - 3 ph

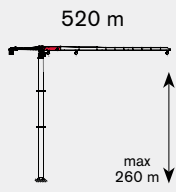
Hoisting · Sollevamento · Heben · Levage · Elevación · Elevação · Подъем

	SR WB 66-100/4F		t	m/min	kW	
	SR WB 66-100/4F		10	0 → 28	66	
			7,1	0 → 45		
			4,2	0 → 70		
			2,5	0 → 112		
			20	0 → 14		
			14,2	0 → 22		
			8,4	0 → 35		
			5	0 → 56		

Hoisting Speed · Velocità di Sollevamento · Heben Geschwindigkeit · Vitesse de Levage · Velocidad de Elevación · Velocidade de içamento · Скорость подъема

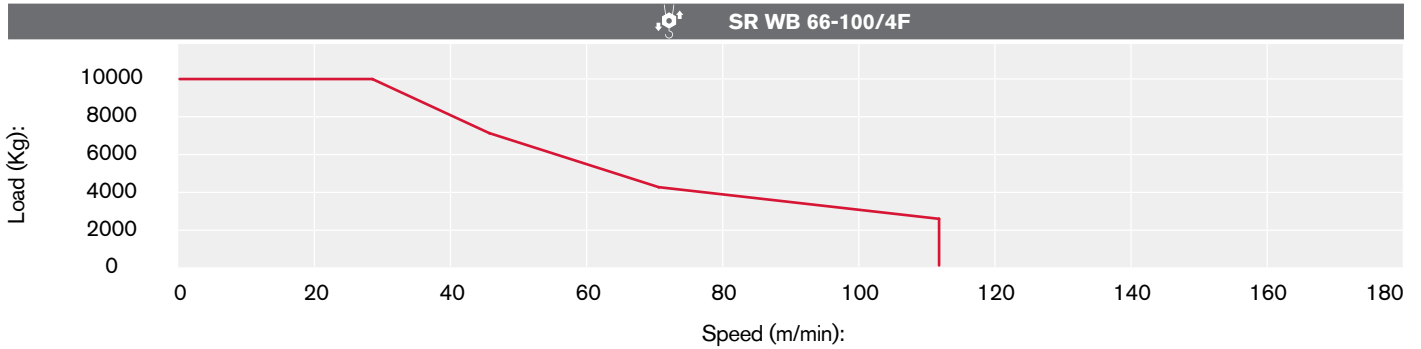

Additional Specifications · Altre movimentazioni · Weitere Leistungsdaten · Spécifications additionnelles · Otras prestaciones · Especificações adicionais · Дополнительные спецификации



	FU 9-320/4	0 → 77 m/min	1 x 9,0 kW
	K WB 120/4	0 → 0,75 min ⁻¹	2 x 100 Nm (35m - 50m) 3 x 100 Nm (55m - 80m)
	SR 10-190/4	0 → 25 m/min	4 x 7,5 kW

TRANSPORTATION





Transport · Trasporto · Transport · Transporte · Transporte · Транспортировка

Packing list

Undercarriage

SK 415-20	DESCRIPTION · DESCRIZIONE · BESCHREIBUNG · DESCRIPTION · DESCRIÇÃO · DESCRIÇÃO · ОПИСАНИЕ	WIDTH · LARGHEZZA · BREITE · LARGEUR · ANCHURA · LARGURA · ШИРИНА	HEIGHT · ALTEZZA · HÖHE · HAUTEUR · ALTURA · ALTURA · ВЫСОТА	QUANTITY · QUANTITÀ · QUANTITÉ · MENGE · QUANTITÉ · CANTIDAD · QUANTIDADE · КОЛИЧЕСТВО	WEIGHT · PESO · GEWICHT · POIDS · PESO · PESO · ВЕС
	U821 UNDERCARRIAGE	10,54 m	2,76 m	0,85 m	7760 kg
	TS 212 FOUNDATION ANCHOR	0,60 m	0,60 m	1,00 m	300 kg





Tower

	TOWER SECTION TS 212.1	5,94 m	2,37 m	2,44 m	4220 kg
	TOWER SECTION TSV 212.1	9,50 m	3,00 m	3,05 m	9300 kg
	TOWER SECTION TSK 212	3,14 m	2,64 m	2,30 m	2850 kg
	SLEWING UNIT	3,45 m	2,17 m	2,00 m	11900 kg











Cab

	CAB EVO 15	3,67 m	2,20 m	2,46 m	1678 Kg
---	------------	--------	--------	--------	---------

Upper Part

	JIB SECTION NO.1	11,86 m	1,97 m	2,20 m	3010 kg
	JIB SECTION NO.2	12,34 m	1,97 m	2,20 m	2960 kg
	JIB SECTION NO.3	11,84 m	1,97 m	2,31 m	2030 kg
	JIB SECTION NO.4	5,69 m	1,97 m	1,91 m	830 kg
	JIB SECTION NO.5	10,67 m	1,97 m	2,10 m	2000 kg
	JIB SECTION NO.6	10,80 m	1,97 m	1,93 m	1340 kg
	JIB SECTION NO.7	10,21 m	1,97 m	1,91 m	900 kg

Upper Part

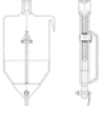
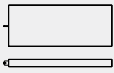
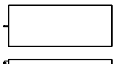
SK 415-20	DESCRIPTION · DESCRIZIONE · BESCHREIBUNG · DESCRIPTION · DESCRIPCIÓN · DESCRIÇÃO · ОПИСАНИЕ	WIDTH · LARGHEZZA · BREITE · LARGEUR · ANCHURA · LARGURA · ШИРИНА	HEIGHT · ALTEZZA · HÖHE · HAUTEUR · ALTURA · ALTURA · · ВЫСОТА	QUANTITY · QUANTITÀ · MENGE · QUANTITÉ · · CANTIDAD · QUANTIDADE · КОЛИЧЕСТВО	WEIGHT · PESO · GEWICHT · POIDS · PESO · PESO · ВЕС
	JIB SECTION NO.8	5,20 m	1,97 m	1,88 m	400 kg
	JIB SECTION NO.9	5,75 m	1,97 m	1,93 m	850 kg
	JIB TIP SECTION	1,37 m	2,00 m	0,90 m	330 kg
	TOWERTOP CPL	8,94 m	2,18 m	1,98 m	3750 kg
	OUTER JIB SUPPORT "A" FRAME	6,58 m	1,73 m	1,42 m	255 kg
	HOIST WINCH SR WB 66-100/4F	2,80 m	2,57 m	1,70 m	3750 kg
	COUNTERJIB G2	11,61 m	2,00 m	1,69 m	4700 kg
	COUNTERJIB G1	9,71 m	2,00 m	0,62 m	2400 kg
	OUTER TROLLEY	1,70 m	2,24 m	1,35 m	466 kg
	OUTER HOIST BLOCK	0,60 m	0,25 m	1,90 m	525 kg
	INNER TROLLEY	1,70 m	2,24 m	1,35 m	301 kg
	INNER HOIST BLOCK	0,65 m	0,25 m	1,40 m	400 kg
	COUNTERWEIGHT BLOCK 3.10 T	4,47 m	0,19 m	1,81 m	3100 kg
	COUNTERWEIGHT FRAME 3.10 T	4,47 m	0,19 m	1,81 m	280 kg

NOTES

Appunti · Notizen · Note · Apunte · Notas · Заметки

TEREX CRANES

Tower Cranes

Via delle Innovazioni, 17
33074 Fontanafredda (PN)
Italy

Ph: +39 0434 989111
Email: info.cranes@terex.com

Rough Terrain Cranes

Via Cassoletta, 76 - Fraz. Crespellano
40053 Valsamoggia (BO)
Italy

Ph: +39 051 6501011
Email: info.cranes@terex.com

December 2019. Product specifications and prices are subject to change without notice or obligation. The photographs and/or drawings in this document are for illustrative purposes only. Refer to the appropriate Operator's Manual for instructions on the proper use of this equipment. Failure to follow the corresponding Operator's Manual when using our equipment or to otherwise act responsibly may result in serious injury or death. The only warranty applicable to our equipment is the standard written warranty applicable to the particular product and sale and Terex makes no other warranty, express or implied. Products and services listed may be trademarks, service marks or trade-names of Terex Corporation and/or its subsidiaries in the USA and other countries. All rights are reserved. Terex, the Terex Crown design and Works For You are trademarks of Terex Corporation or its subsidiaries.

Dicembre 2019. Specifiche e prezzi dei prodotti sono soggetti a modifica senza preavviso o altro obbligo. Le fotografie e i disegni in questo documento hanno esclusivamente scopo illustrativo. Consulta il Manuale dell'operatore pertinente per trovare istruzioni per l'utilizzo corretto di questo macchinario. La mancata osservanza delle istruzioni contenute nel relativo Manuale dell'operatore durante l'uso del macchinario e altri comportamenti irresponsabili possono provocare gravi lesioni, anche mortali. L'unica garanzia applicabile ai nostri macchinari è la garanzia scritta standard applicabile al particolare prodotto e alla particolare vendita e Terex è esonerata dal fornire qualsiasi altra garanzia, esplicita o implicita. I prodotti e servizi elencati possono essere dei marchi di fabbrica, marchi di servizio o nomi commerciali di Terex Corporation, e/o delle rispettive società affiliate negli Stati Uniti d'America e in molte altre nazioni. Tutti i diritti riservati. Terex, il marchio Terex Crown e Works for You sono marchi di proprietà di Terex Corporation o delle sue società affiliate.

Dezember 2019. Irrtum und Änderungen der Produktspezifikationen vorbehalten. Die in diesem Dokument enthaltenen Fotos und/oder Zeichnungen dienen rein anschaulichen Zwecken. Für den sachgemäßen Gebrauch der Maschinen ist das entsprechende Bedienerhandbuch heranzuziehen. Unsachgemäßer Umgang mit bzw. unsachgemäßer Einsatz unserer Maschinen kann zu schweren gesundheitlichen Schäden bis hin zum Tod führen. Für unsere Produkte wird ausschließlich die entsprechende, schriftlich niedergelegte Standardgarantie gewährt. Terex leistet keinerlei darüber hinausgehende Garantie, weder ausdrücklich noch stillschweigend. Die genannten Produkte und Dienstleistungen sind in den USA und anderen Ländern ggf. Marken, Dienstleistungsmarken oder Handelsnamen der Terex Corporation und/oder ihrer Tochtergesellschaften. Alle Rechte vorbehalten. Terex, das Terex Kronenlogo und Works For You sind Marken in Eigentum der Terex Corporation bzw. ihrer Tochtergesellschaften.

Décembre 2019. Les caractéristiques et prix des produits peuvent faire l'objet de modifications sans notification préalable. Les photographies ou dessins présentés dans ce document servent uniquement à des fins d'illustration. Pour connaître les instructions relatives à l'utilisation correcte de cet équipement, veuillez vous référer au manuel de l'utilisateur correspondant. Le non-respect du manuel d'utilisateur correspondant lors de l'utilisation de notre équipement ou des actes irresponsables risquent de provoquer de graves blessures, voire un décès. La seule garantie applicable à nos équipements est la garantie écrite standard applicable au produit et à la vente spécifiques. Terex ne délivre aucune autre garantie, expresse ou implicite. Les produits et les services mentionnés peuvent être des marques, des marques de service ou des appellations commerciales de Terex Corporation et/ou de ses filiales aux États-Unis et dans d'autres pays. Tous droits réservés. Terex, le design Terex Crown et Works For You sont des marques déposées de Terex Corporation ou de ses filiales.

Diciembre 2019. Las especificaciones y los precios de los productos están sujetos a cambios sin necesidad de previo aviso ni ninguna otra obligación. Las fotografías y/o dibujos de este documento tienen un fin meramente ilustrativo. Consulte el correspondiente manual de instrucciones del operario para obtener más información sobre el uso correcto de esta maquinaria. No respetar el manual del operario al utilizar la maquinaria o actuar de forma irresponsable puede provocar lesiones graves e incluso mortales. La única garantía aplicable a nuestra maquinaria es la garantía escrita estándar de cada producto y venta. Terex no amplía dicha garantía de forma expresa ni implícita. Los productos y servicios mencionados pueden ser marcas comerciales, marcas de servicio o nombres de marca de Terex Corporation o de alguna de sus filiales en Estados Unidos y otros países. Todos los derechos reservados. Terex, el diseño de la corona Terex y Works For You son marcas registradas de Terex Corporation o de sus filiales.

Dezembro 2019. Especificações e preços dos produtos sujeitos a alteração sem aviso prévio ou obrigações. As fotografias e/ou desenhos neste documento são apenas para fins ilustrativos. Consulte o respectivo Manual do Operador para instruções sobre o uso correto deste equipamento. Deixar de acompanhar o respectivo Manual do Operador ao usar o nosso equipamento ou, por qualquer outra forma, deixar de agir de maneira responsável pode resultar em lesões corporais graves ou a morte. A única garantia aplicável ao nosso equipamento é a garantia padrão por escrito correspondente ao produto específico vendido. A Terex não dá outras garantias, expressas ou implícitas. Os produtos e serviços listados podem ser marcas comerciais, marcas de serviço ou nomes-fantasia da Terex Corporation e/ou suas subsidiárias nos EUA e em outros países. Todos os direitos reservados. Terex, o desenho da Coroa Terex e a expressão Works For You são marcas comerciais da Terex Corporation ou suas subsidiárias.

декабрь 2019 г. года Технические характеристики и цены могут изменяться без предварительного уведомления и без каких-либо обязательств для производителя. Фотографии и (или) чертежи в настоящем документе служат только в качестве иллюстраций. Инструкции по надлежащей эксплуатации данного оборудования см. в соответствующем руководстве для оператора. Невыполнение указаний соответствующих руководств для оператора при эксплуатации оборудования или другие безответственные действия могут повлечь серьезные травмы или смерть. Единственной гарантией, действующей в отношении нашего оборудования, является стандартная форма письменной гарантии на данный тип оборудования и на условия его продажи. Terex не дает никаких других гарантий: ни ясно выраженных, ни подразумеваемых. Перечисленные продукты и услуги могут быть торговыми марками, знаками обслуживания или торговыми наименованиями Terex Corporation и / или ее дочерних компаний в США и других странах. Все права защищены. Terex, изображение короны Terex и Works for You являются торговыми марками, принадлежащими корпорации Terex или ее дочерним компаниям.



www.terex.com/cranes

Brochure Reference: TC-DS-M-E/I/G/F/S/P/R-SK415-20-12/19



WORKS FOR YOU.™